

# SPECIFICATION FOR APPROVAL

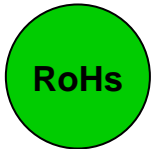

CUSTOMER

---

CUSTOMER'S DWG NO.

REVISION NO.

---

CUSTOMER'S PART NO.

---

TECSTAR'S PART NO.

TL160808-1R0K

---

QUANTITY

PCS

---

ITEM

DATE

AUG/27/2009

---

	“√”	CUSTOMER'S SIGNATURE	NOTE
FULL APPROVED			
CONDITONAL APPROVED			
REJECTED			



## TECSTAR TECHNOLOGY CO., LTD.

NO. 820-1 Kou Shih Rd. Yang Mei Chen

Taoyuan Hsien, Taiwan, R.O.C.

TEL : 886-3-4788701

FAX : 886-3-4788702

www tecstar.com.tw

# SPECIFICATION FOR APPROVAL

CUSTOMER:				CUSTOMER'S P/N:				
VENDOR'S P/N:				TL160808-1R0K				
<p>DIMENSION:(m/m)</p>				A	1.6 ± 0.2	m/m		
				B	0.8 ± 0.2	m/m		
				C	0.8 ± 0.2	m/m		
				D	0.3 ± 0.2	m/m		
				E		m/m		
				F		m/m		
				G		m/m		
				H		m/m		
				I		m/m		
				J		m/m		
				K		m/m		
				L		m/m		
				M		m/m		
				N		m/m		
O		m/m						
<b>ELECTRICAL REQUIREMENTS</b>				<b>TEST INSTRUMENTS</b>				
L	1.0 ± 10%	μH	TEST FREQ.	<input checked="" type="radio"/> HP 4338A MILLIOHMMETER <input type="radio"/> HP 4195A NETWORK/SPECTRUM ANALYZER <input type="radio"/> HP 4284A BIAS CURRENT SOURCE <input type="radio"/> HP 4285A PRECISION LCR METER <input type="radio"/> HP 4286A PRECISION LCR METER <input checked="" type="radio"/> HP 4291B RF IMPEDANCE /MATERIAL ANALYZER <input type="radio"/> HP 6632A DC POWER SUPPLY				
			10MHz/100mV					
Q	35	MIN.	TEST FREQ.					
			10MHz/100mV					
Srf	75	MHz MIN.	TEST FREQ.					
			MHz					
Rdc	0.60	OHM. MAX.	TEST FREQ.					
			MHz					
Idc	25	mA MAX.	TEST FREQ.					
			MHz					
DRAWN BY			CHECKED BY			APPROVED BY		
Juli Wang			John Chuang			Lionel Lin		

# TEST DATA

CUSTOMER:							
CUSTOMER'S P/N:						SERIES NO:	TL2704
VENDOR'S P/N:		TL160808-1R0K				DATE:	27-AUG-2009
MEAS	A	B	C	D	L	Q	Rdc
ITEM	(m/m)	(m/m)	(m/m)	(m/m)	( $\mu$ H)		( $\Omega$ )
SPEC	$1.6 \pm 0.2$	$0.8 \pm 0.2$	$0.8 \pm 0.2$	$0.3 \pm 0.2$	$1.0 \pm 10\%$	35 MIN.	0.60 MAX.
TEST FREQ.					10MHz	10MHz	
1	1.62	0.83	0.80	0.31	1.06	63.3	0.361
2	1.63	0.82	0.83	0.32	1.03	61.1	0.378
3	1.60	0.83	0.82	0.32	0.95	55.7	0.369
4	1.61	0.84	0.84	0.33	1.04	58.6	0.346
5	1.61	0.81	0.83	0.30	1.04	61.7	0.369
6	1.64	0.81	0.82	0.33	0.98	58.2	0.345
7	1.62	0.82	0.82	0.31	1.07	60.3	0.373
8	1.60	0.82	0.80	0.33	0.97	59.9	0.362
9	1.63	0.81	0.81	0.30	0.96	60.2	0.373
10	1.61	0.84	0.83	0.32	0.98	59.8	0.365
AVG.	1.62	0.82	0.82	0.32	1.01	59.9	0.364
R	0.04	0.03	0.04	0.03	0.12	7.6	0.033
DRAWN BY			CHECKED BY			APPROVED BY	
Juli Wang			John Chuang			Lionel Lin	

# TYPICAL ELECTRICAL CHARACTERISTICS CURVE

TL160808 Type

Inductance VS. Frequency

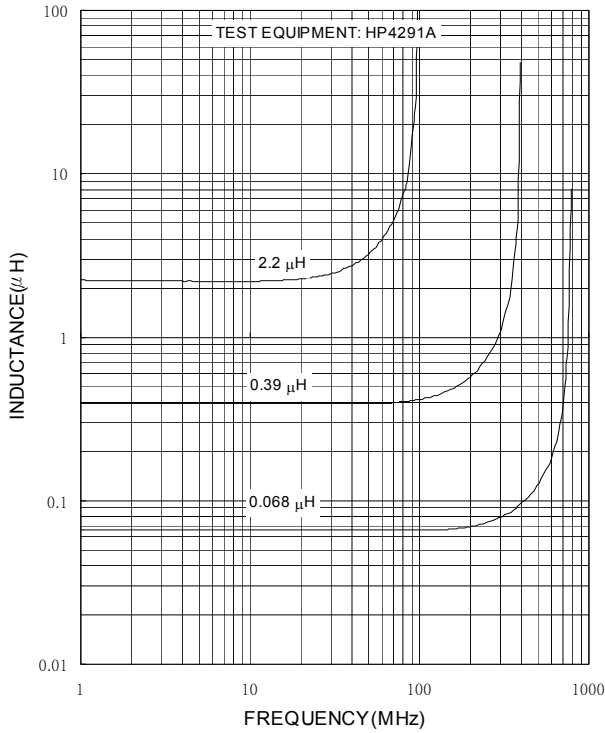

Impedance VS. Frequency

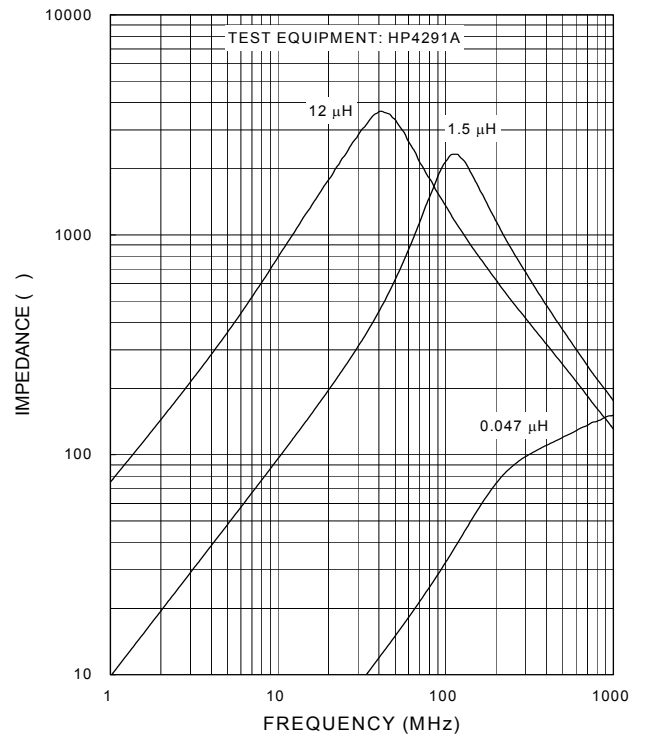

Inductance VS. Temperature

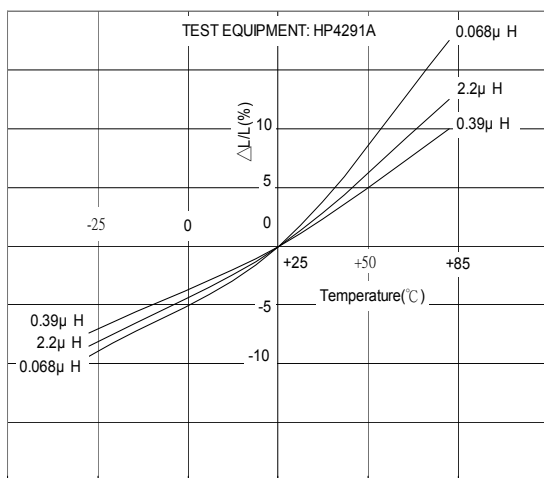

Q VS. Frequency

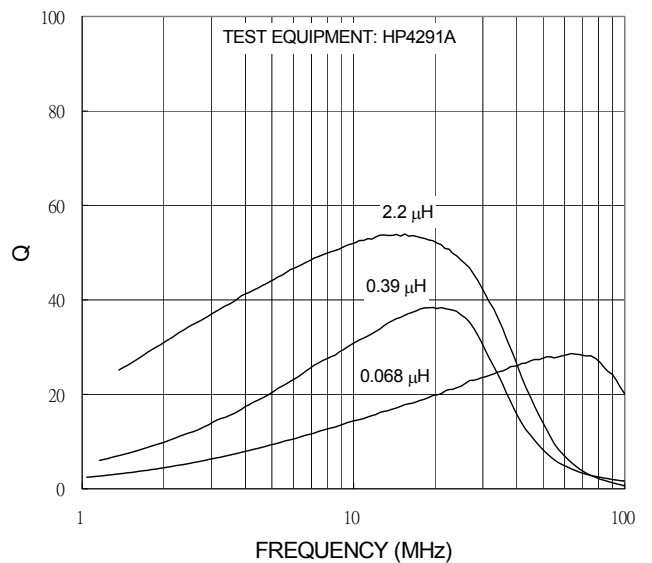

# RELIABILITY TEST

Item	Performance	Test condition
Operating temperature range	-55 °C to + 125 °C	
Storage temperature and umidity ranges	40 °C MAX., 70% RH MAX.	
Soldering heat resistance	The chip shall not be cracks. More than 75% of terminal electrode shall be covered with solder.	Preheat: 150 °C, 60 seconds Solder temperature : 260 ± 5 °C Flux: Rosin Dip time: 10 ± 1 seconds

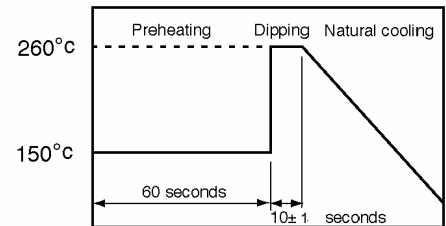

Solderability	More than 90% of the terminal electrode shall be covered with new solder.	Preheat: 150 °C, 60 seconds Solder temperature: 245 ± 5 °C Flux: Rosin Dip time: 4 ± 1 seconds
---------------	---	---

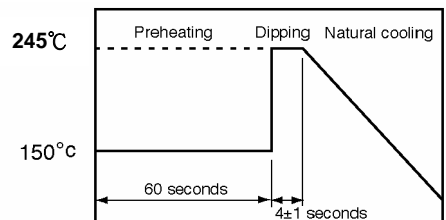

## Recommended Soldering Conditions

(REFLOW TEMPERATURE PROFILE) Lead-Free

A	$260 \pm 5^{\circ}\text{C}$
B	$230 \pm 5^{\circ}\text{C}$
C	$30 \pm 10 \text{ sec}$
D	$150^{\circ}\text{C}$
E	$180^{\circ}\text{C}$
F	$90 \pm 30 \text{ sec}$

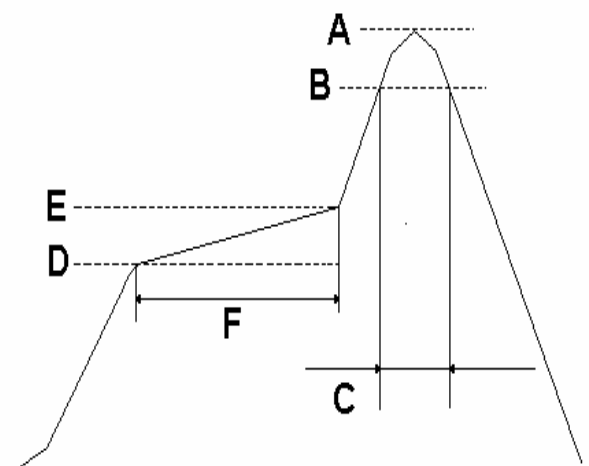

# RELIABILITY TEST

Terminal strength

The terminal electrode and the body shall not be damaged by the forces applied on the right conditions.

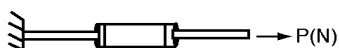

Type	P (kgf)	Time (s)
T□100505	0.3	
T□160808	0.5	
T□201209	0.6	
T□201212	0.8	
T□321611	1.0	
T□322513	1.0	30 ± 5
T□451616	1.0	
T□453215	1.5	
TA3216M4	0.5	

Bending strength

The body shall not be damaged by the forces applied on the right conditions.

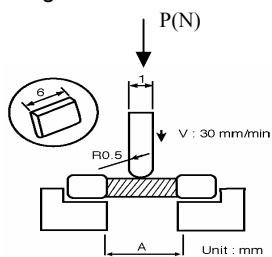

Type	A (mm)	P (kgf)
T□160808	1.0	0.5
T□201209	1.4	1.0
T□201212	1.4	1.2
T□321611	2.0	2.0
T□322513	2.0	2.5
T□451616	2.5	2.5
T□453215	2.7	2.5
TA3216M4	1.4	1.0

# RELIABILITY TEST

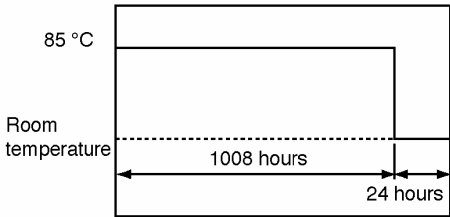
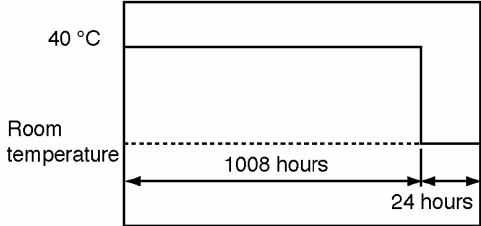
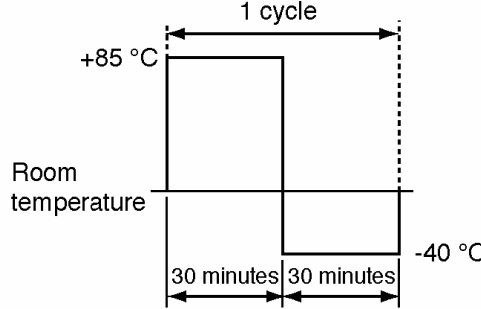
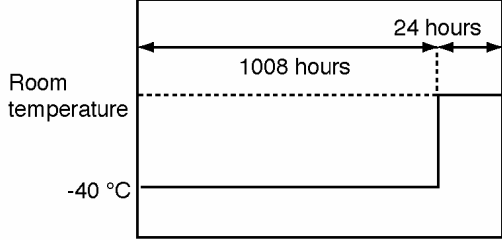
Item	Performance	Test condition
High temperature resistance	Appearance : Ferrite shall not be damaged. Inductance : Within $\pm 10\%$ of the initial value. Q: Within $\pm 30\%$ of the initial value.	Temperature: $85\pm 2^{\circ}\text{C}$ Testing time: $1008\pm 12$ hours Measurement: After placing for 24 hours min 
Humidity resistance	Appearance: Ferrite shall not be damaged. Inductance: Within $\pm 10\%$ of the initial value Q: Within $\pm 30\%$ of the initial value.	Humidity: 90 to 95% RH Temperature: $40\pm 2^{\circ}\text{C}$ Testing time: $1008\pm 12$ hours Measurement: After placing for 24 hours min 
Thermal Shock	Appearance: Cracking, chipping or any other defects harmful to the characteristics shall not be allowed. Inductance: Within $\pm 10\%$ of the initial value Q: Within $\pm 30\%$ of the initial value.	Temperature: $-40^{\circ}\text{C}$ , $+85^{\circ}\text{C}$ , kept stabilized for 30 minutes each Cycle: 100 cycles Measurement: After placing for 24 hours min 
Low temperature storage life test	Appearance: Cracking, chipping or any other defects harmful to the characteristics shall not be allowed. Inductance: Within $\pm 10\%$ of the initial value. Q: Within $\pm 30\%$ of the initial value.	Temperature: $-40\pm 2^{\circ}\text{C}$ Testing time: $1008\pm 12$ hours Measurement: After placing for 24 hours min 

# PACKAGING

- Tape dimensions and packaging quantities

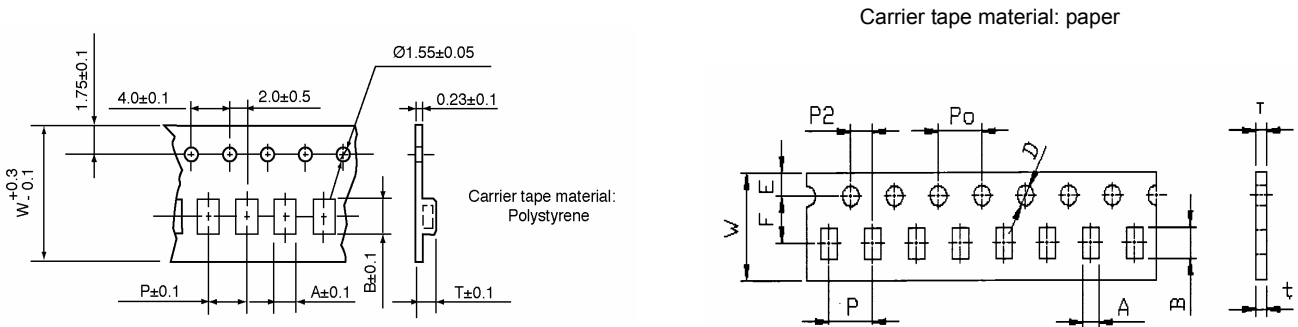

material: Paper ( Dimensions in mm)						
TYPE	A	B	W	P	T	CHIPS / REEL
100505	0.62	1.12	8	2	0.60	10000
160808	1.10	1.90	8	4	0.95	4000
201209	1.50	2.30	8	4	0.95	4000
material: Polystyrene ( Dimensions in mm)						
TYPE	A	B	W	P	T	CHIPS / REEL
160808	1.01	1.80	8	4	1.02	4000
201209	1.42	2.25	8	4	1.04	4000
201212	1.50	2.35	8	4	1.45	2000
321611	1.88	3.50	8	4	1.27	3000

- Reel dimensions

Material: Paper, Plastic

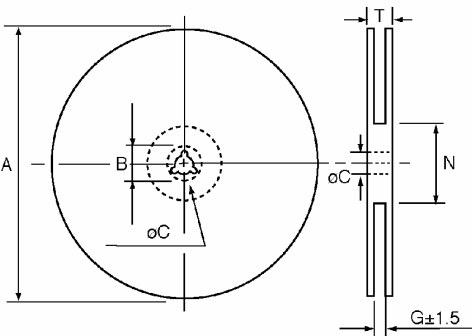

Dimensions in mm

TYPE	8mm	12mm
A	178±2	178±2
B	21.0±0.8	21.0±0.8
C	13.0±0.8	13.0±0.8
G	10.0	14.0
N	75	75
T	12.5	16.5

