

SPECIFICATION FOR APPROVAL

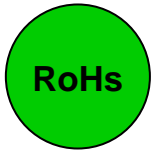

CUSTOMER

CUSTOMER'S DWG NO.

REVISION NO.

CUSTOMER'S PART NO.

TECSTAR'S PART NO.

TL160808-8R2K

QUANTITY

PCS

ITEM

DATE

SEP/03/2009

	“√”	CUSTOMER'S SIGNATURE	NOTE
FULL APPROVED			
CONDITONAL APPROVED			
REJECTED			



TECSTAR TECHNOLOGY CO., LTD.

NO. 820-1 Kou Shih Rd. Yang Mei Chen

Taoyuan Hsien, Taiwan, R.O.C.

TEL : 886-3-4788701

FAX : 886-3-4788702

www tecstar.com.tw

SPECIFICATION FOR APPROVAL

CUSTOMER:		CUSTOMER'S P/N:	
VENDOR'S P/N:		TL160808-8R2K	
<p>DIMENSION:(m/m)</p>		A	1.6 ± 0.2 m/m
		B	0.8 ± 0.2 m/m
		C	0.8 ± 0.2 m/m
		D	0.3 ± 0.2 m/m
		E	m/m
		F	m/m
		G	m/m
		H	m/m
		I	m/m
		J	m/m
		K	m/m
		L	m/m
		M	m/m
		N	m/m
O	m/m		
ELECTRICAL REQUIREMENTS		TEST INSTRUMENTS	
L	8.2 ± 10% μH	TEST FREQ.	4MHz/100mV
Q	35 MIN.	TEST FREQ.	4MHz/100mV
Srf	18 MHz MIN.	TEST FREQ.	MHz
Rdc	2.10 OHM. MAX.	TEST FREQ.	MHz
Idc	5 mA MAX.	TEST FREQ.	MHz
DRAWN BY		CHECKED BY	
Juli Wang		John Chuang	
		APPROVED BY	
		Lionel Lin	

- HP 4338A MILLIOHMMETER
- HP 4195A NETWORK/SPECTRUM ANALYZER
- HP 4284A BIAS CURRENT SOURCE
- HP 4285A PRECISION LCR METER
- HP 4286A PRECISION LCR METER
- HP 4291B RF IMPEDANCE /MATERIAL ANALYZER
- HP 6632A DC POWER SUPPLY

TEST DATA

CUSTOMER:							
CUSTOMER'S P/N:						SERIES NO:	TL3044
VENDOR'S P/N:		TL160808-8R2K				DATE:	03-SEP-2009
MEAS	A	B	C	D	L	Q	Rdc
ITEM	(m/m)	(m/m)	(m/m)	(m/m)	(μ H)		(Ω)
SPEC	1.6 ± 0.2	0.8 ± 0.2	0.8 ± 0.2	0.3 ± 0.2	$8.2 \pm 10\%$	35 MIN.	2.10 MAX.
TEST FREQ.					4MHz	4MHz	
1	1.59	0.78	0.80	0.32	8.31	64.2	1.239
2	1.60	0.82	0.78	0.30	8.29	56.0	1.202
3	1.61	0.79	0.81	0.31	8.28	59.9	1.179
4	1.60	0.81	0.79	0.31	8.41	61.9	1.278
5	1.60	0.80	0.80	0.33	8.17	59.7	1.194
6	1.62	0.81	0.81	0.28	8.34	61.1	1.272
7	1.63	0.78	0.81	0.30	8.41	64.0	1.211
8	1.61	0.82	0.79	0.32	8.05	61.5	1.186
9	1.63	0.80	0.81	0.29	8.27	59.2	1.246
10	1.60	0.81	0.80	0.31	8.24	59.8	1.214
AVG.	1.61	0.80	0.80	0.31	8.28	60.7	1.222
R	0.04	0.04	0.03	0.05	0.36	8.2	0.099
DRAWN BY			CHECKED BY			APPROVED BY	
Juli Wang			John Chuang			Lionel Lin	

TYPICAL ELECTRICAL CHARACTERISTICS CURVE

TL160808 Type

Inductance VS. Frequency

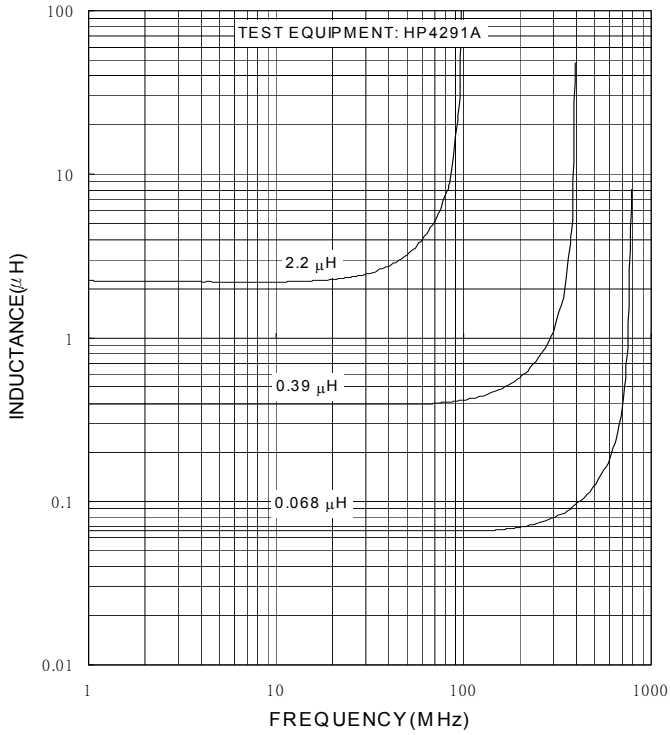

Impedance VS. Frequency

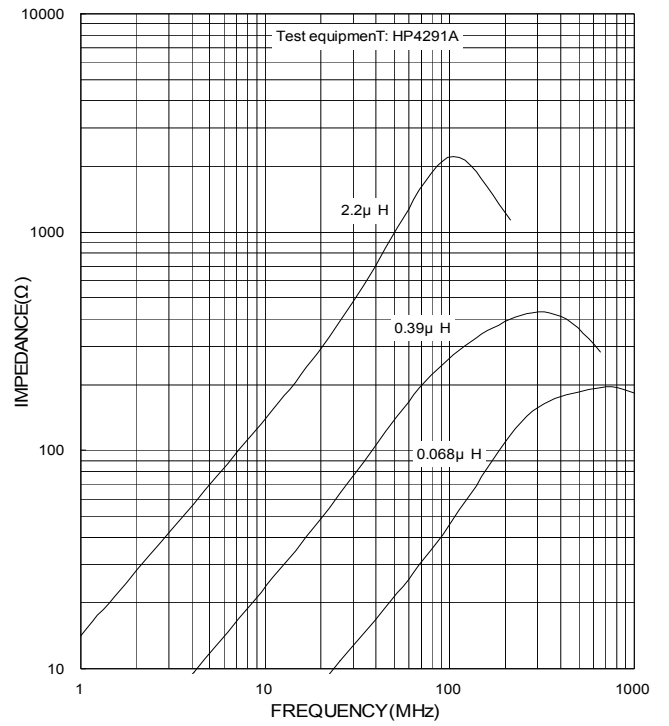

Inductance VS. Temperature

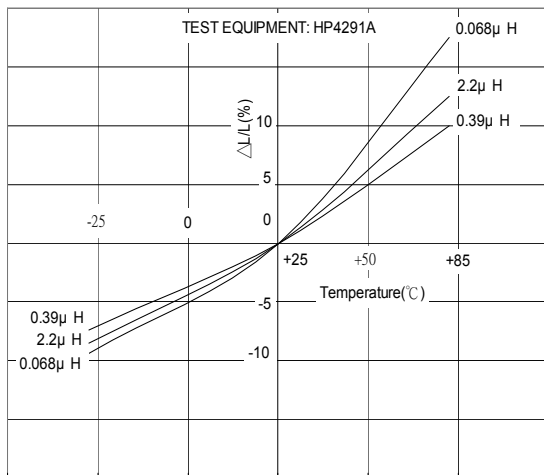

Q VS. Frequency

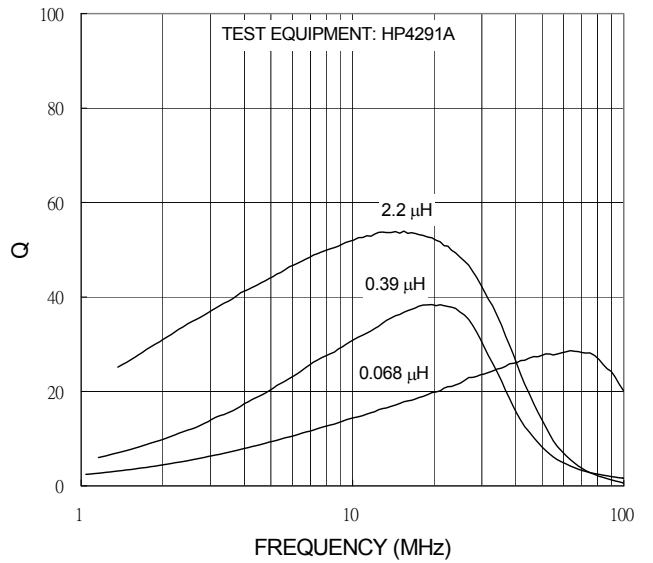

RELIABILITY TEST

Item	Performance	Test condition
Operating temperature range	-55 °C to + 125 °C	
Storage temperature and umidity ranges	40 °C MAX., 70% RH MAX.	
Soldering heat resistance	The chip shall not be cracks. More than 75% of terminal electrode shall be covered with solder.	Preheat: 150 °C, 60 seconds Solder temperature : 260 ± 5 °C Flux: Rosin Dip time: 10 ± 1 seconds

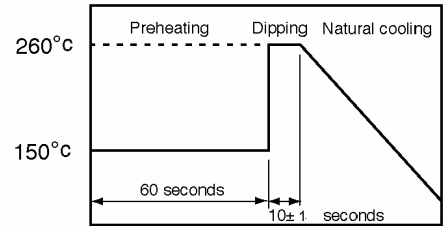

Solderability	More than 90% of the terminal electrode shall be covered with new solder.	Preheat: 150 °C, 60 seconds Solder temperature: 245 ± 5 °C Flux: Rosin Dip time: 4 ± 1 seconds
---------------	---	---

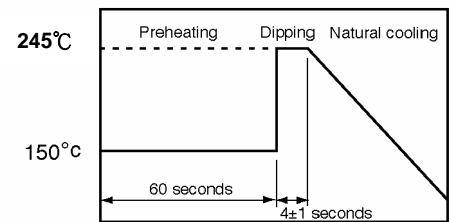

Recommended Soldering Conditions

(REFLOW TEMPERATURE PROFILE) **Lead-Free**

A	$260 \pm 5^{\circ}\text{C}$
B	$230 \pm 5^{\circ}\text{C}$
C	$30 \pm 10 \text{ sec}$
D	150°C
E	180°C
F	$90 \pm 30 \text{ sec}$

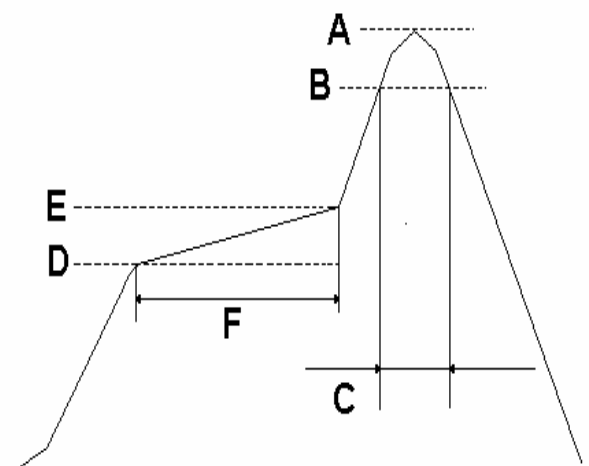

RELIABILITY TEST

Terminal strength

The terminal electrode and the body shall not be damaged by the forces applied on the right conditions.

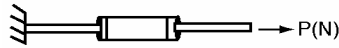

Type	P (kgf)	Time (s)
T□100505	0.3	
T□160808	0.5	
T□201209	0.6	
T□201212	0.8	
T□321611	1.0	
T□322513	1.0	30 ± 5
T□451616	1.0	
T□453215	1.5	
TA3216M4	0.5	

Bending strength

The body shall not be damaged by the forces applied on the right conditions.

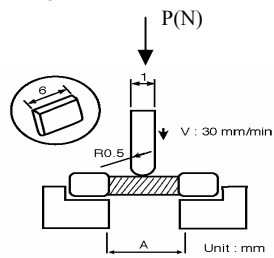

Type	A (mm)	P (kgf)
T□160808	1.0	0.5
T□201209	1.4	1.0
T□201212	1.4	1.2
T□321611	2.0	2.0
T□322513	2.0	2.5
T□451616	2.5	2.5
T□453215	2.7	2.5
TA3216M4	1.4	1.0

RELIABILITY TEST

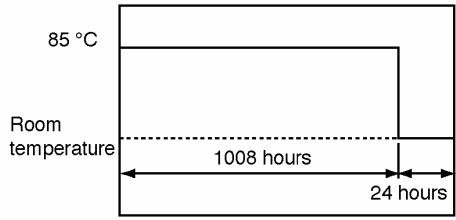
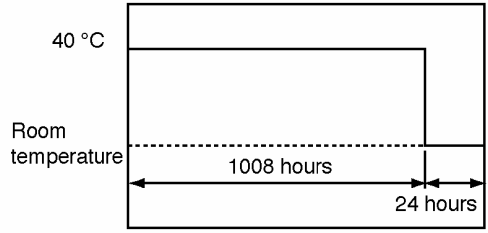
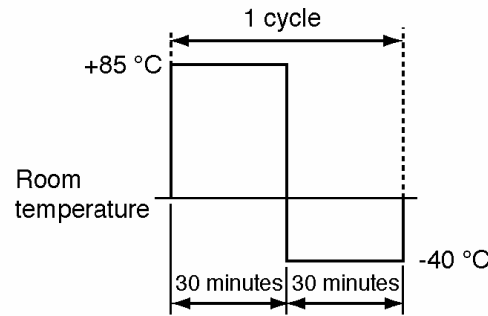
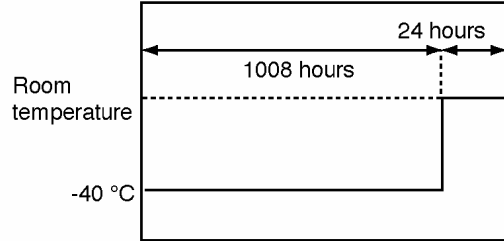
Item	Performance	Test condition
High temperature resistance	Appearance : Ferrite shall not be damaged. Inductance : Within±10% of the initial value. Q: Within±30% of the initial value.	Temperature: 85±2°C Testing time: 1008±12 hours Measurement: After placing for 24 hours min 
Humidity resistance	Appearance: Ferrite shall not be damaged. Inductance: Within±10% of the initial value Q: Within±30 % of the initial value.	Humidity: 90 to 95% RH Temperature: 40±2°C Testing time: 1008±12 hours Measurement: After placing for 24 hours min 
Thermal Shock	Appearance: Cracking, chipping or any other defects harmful to the characteristics shall not be allowed. Inductance: Within±10% of the initial value Q: Within±30% of the initial value.	Temperature: -40°C, +85°C, kept stabilized for 30 minutes each Cycle: 100 cycles Measurement: After placing for 24 hours min 
Low temperature storage life test	Appearance: Cracking, chipping or any other defects harmful to the characteristics shall not be allowed. Inductance: Within±10% of the initial value. Q: Within±30% of the initial value.	Temperature: -40±2°C Testing time: 1008±12 hours Measurement: After placing for 24 hours min 

PACKAGING

- Tape dimensions and packaging quantities

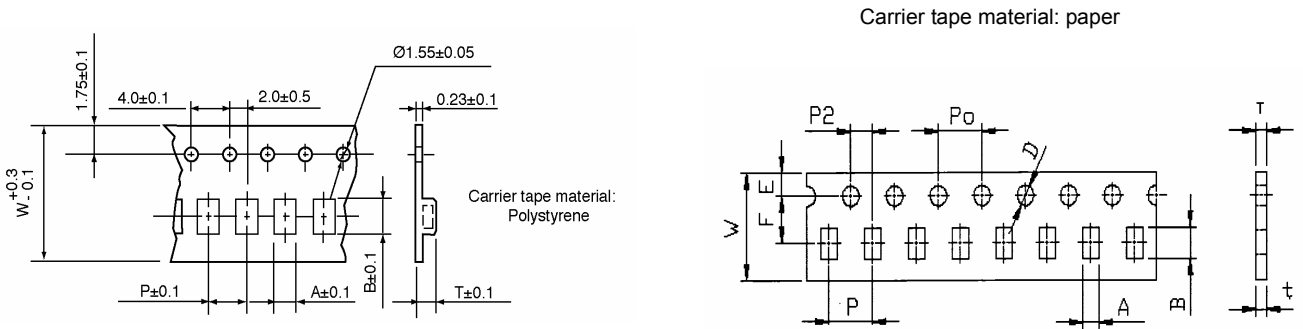

material: Paper (Dimensions in mm)						
TYPE	A	B	W	P	T	CHIPS / REEL
100505	0.62	1.12	8	2	0.60	10000
160808	1.10	1.90	8	4	0.95	4000
201209	1.50	2.30	8	4	0.95	4000
material: Polystyrene (Dimensions in mm)						
TYPE	A	B	W	P	T	CHIPS / REEL
160808	1.01	1.80	8	4	1.02	4000
201209	1.42	2.25	8	4	1.04	4000
201212	1.50	2.35	8	4	1.45	2000
321611	1.88	3.50	8	4	1.27	3000

- Reel dimensions

Material: Paper, Plastic

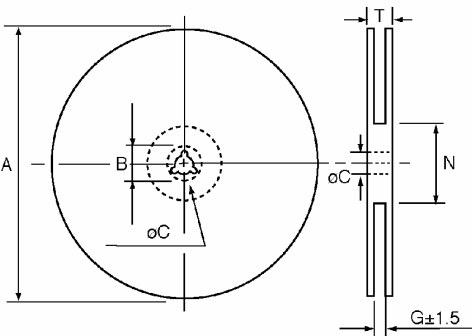

Dimensions in mm

TYPE	8mm	12mm
A	178±2	178±2
B	21.0±0.8	21.0±0.8
C	13.0±0.8	13.0±0.8
G	10.0	14.0
N	75	75
T	12.5	16.5

