

SPECIFICATION FOR APPROVAL

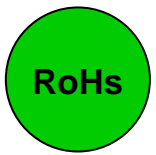

CUSTOMER _____

CUSTOMER'S DWG NO. _____

REVISION NO. _____

CUSTOMER'S PART NO. _____

TECSTAR'S PART NO. _____

TL201209-2R2K

QUANTITY _____

PCS _____

ITEM _____

DATE _____

APR/01/2011

	“√”	CUSTOMER'S SIGNATURE	NOTE
FULL APPROVED			
CONDITONAL APPROVED			
REJECTED			



TECSTAR TECHNOLOGY CO., LTD.

NO. 820-1 Kou Shih Rd. Yang Mei City
Taoyuan Hsien, Taiwan, R.O.C.
TEL : 886-3-4788701
FAX : 886-3-4788702
www.tecstar.com.tw

SPECIFICATION FOR APPROVAL

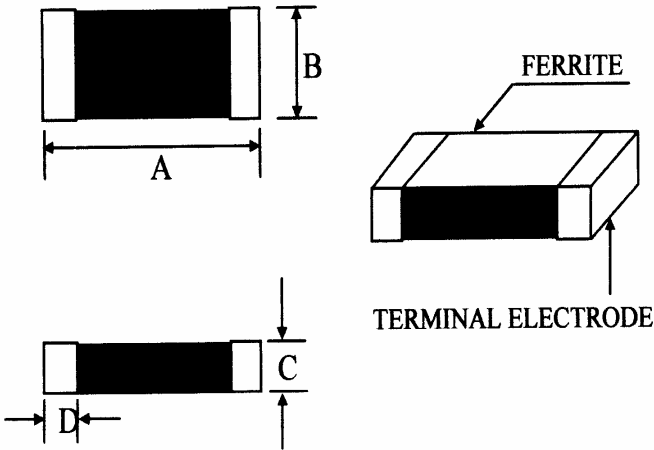
CUSTOMER:		CUSTOMER'S P/N:		
VENDOR'S P/N:		TL201209-2R2K		
<p>DIMENSION:(m/m)</p> 		A	2.0 ± 0.2	m/m
		B	1.2 ± 0.2	m/m
		C	0.9 ± 0.2	m/m
		D	0.5 ± 0.3	m/m
		E		m/m
		F		m/m
		G		m/m
		H		m/m
		I		m/m
		J		m/m
		K		m/m
		L		m/m
		M		m/m
		N		m/m
O		m/m		
ELECTRICAL REQUIREMENTS		TEST INSTRUMENTS		
L	2.20 ± 10% μH	TEST FREQ.	<input checked="" type="radio"/> HP 4338A MILLIOHMMETER <input type="radio"/> HP 4195A NETWORK/SPECTRUM ANALYZER <input type="radio"/> HP 4284A BIAS CURRENT SOURCE <input type="radio"/> HP 4285A PRECISION LCR METER <input type="radio"/> HP 4286A PRECISION LCR METER <input checked="" type="radio"/> HP 4291B RF IMPEDANCE /MATERIAL ANALYZER <input type="radio"/> HP 6632A DC POWER SUPPLY	
Q	45 MIN.	TEST FREQ.		
Srf	50 MHz MIN.	TEST FREQ.		
Rdc	0.65 OHM. MAX.	TEST FREQ.		
Idc	30 mA MAX.	TEST FREQ.		
DRAWN BY		CHECKED BY		APPROVED BY
Juli Wang		John Chuang		Lionel Lin

TEST DATA

CUSTOMER:							
CUSTOMER'S P/N:						SERIES NO:	TL3100
VENDOR'S P/N:		TL201209-2R2K				DATE:	01-APR-2011
MEAS	A	B	C	D	L	Q	Rdc
ITEM	(m/m)	(m/m)	(m/m)	(m/m)	(μ H)		(Ω)
SPEC	2.0 ± 0.2	1.2 ± 0.2	0.9 ± 0.2	0.5 ± 0.3	$2.2 \pm 10\%$	45 MIN.	0.65 MAX.
TEST FREQ.					10 MHz	10 MHz	
1	2.02	1.23	0.89	0.52	2.32	61.4	0.421
2	2.00	1.25	0.90	0.50	2.22	66.3	0.409
3	2.01	1.22	0.88	0.48	2.28	64.5	0.435
4	2.03	1.21	0.89	0.51	2.27	65.5	0.436
5	2.04	1.24	0.90	0.53	2.18	66.6	0.400
6	2.00	1.23	0.89	0.52	2.24	66.7	0.420
7	2.02	1.22	0.87	0.51	2.34	61.1	0.433
8	2.01	1.24	0.89	0.52	2.24	66.5	0.430
9	2.03	1.22	0.90	0.53	2.27	68.1	0.410
10	2.00	1.23	0.89	0.50	2.33	67.2	0.431
AVG.	2.02	1.23	0.89	0.51	2.27	65.4	0.423
R	0.04	0.04	0.03	0.05	0.16	7.0	0.036
DRAWN BY			CHECKED BY			APPROVED BY	
Juli Wang			John Chuang			Lionel Lin	

TYPICAL ELECTRICAL CHARACTERISTICS CURVE

TL2012 Type

Inductance VS. Frequency

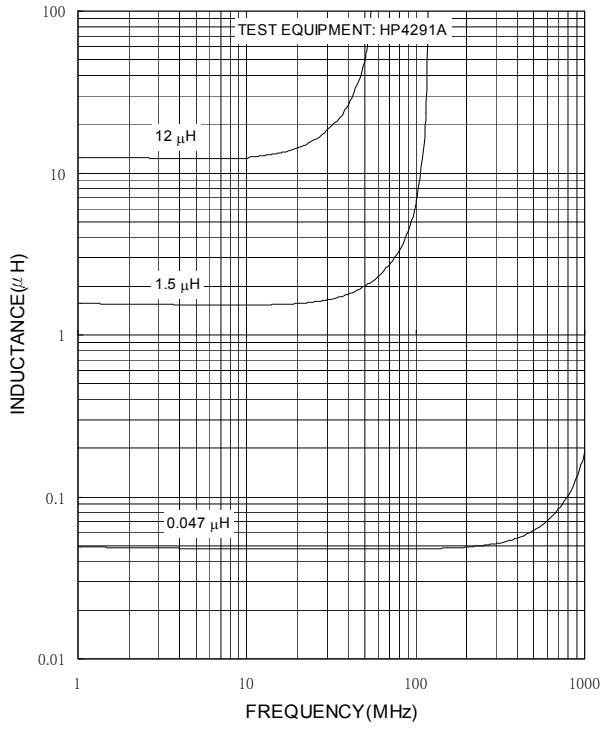

Impedance VS. Frequency

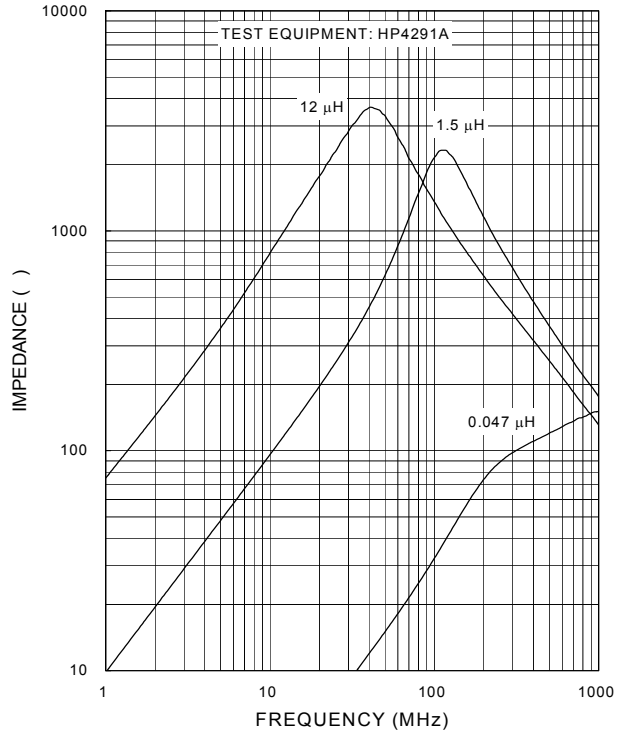

Inductance VS. Temperature

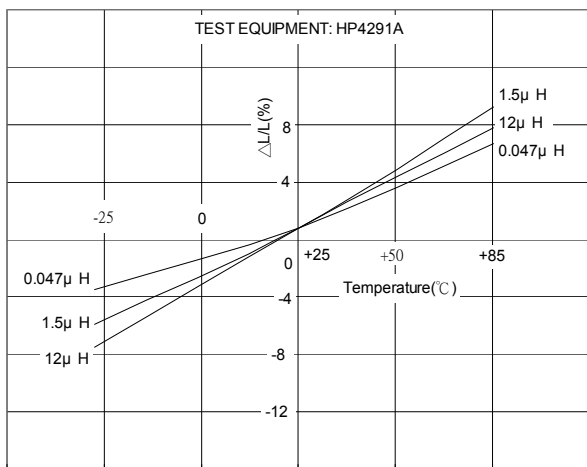

Q VS. Frequency

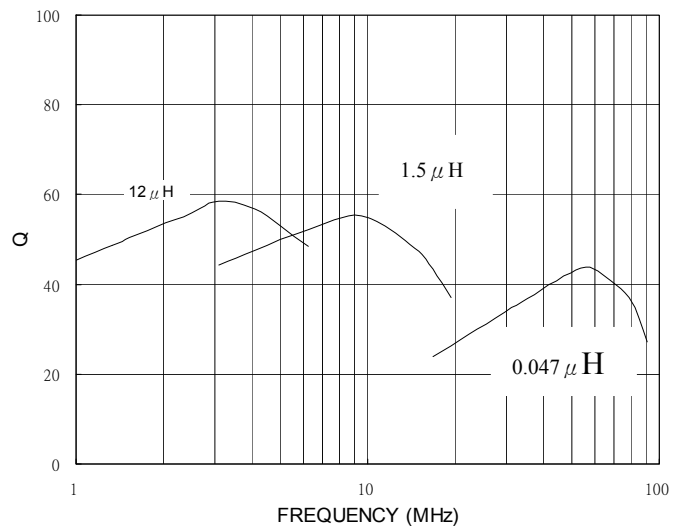

RELIABILITY TEST

Item	Performance	Test condition
Operating temperature range	-55 °C to + 125 °C	
Storage temperature and umidity ranges	40 °C MAX., 70% RH MAX.	
Soldering heat resistance	The chip shall not be cracks. More than 75% of terminal electrode shall be covered with solder.	Preheat: 150 °C, 60 seconds Solder temperature : 260 ± 5 °C Flux: Rosin Dip time: 10 ± 1 seconds
Solderability	More than 90% of the terminal electrode shall be covered with new solder.	Preheat: 150 °C, 60 seconds Solder temperature: 245 ± 5 °C Flux: Rosin Dip time: 4 ± 1 seconds

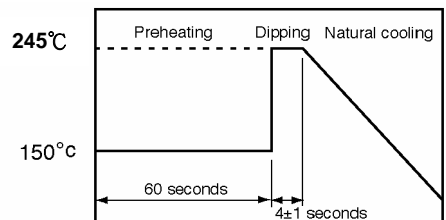
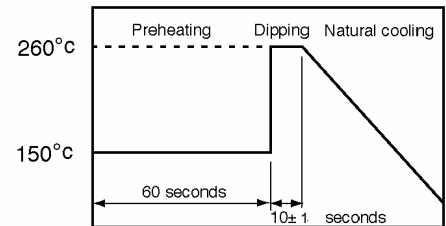

Recommended Soldering Conditions

(REFLOW TEMPERATURE PROFILE) **Lead-Free**

A	$260 \pm 5^{\circ}\text{C}$
B	$230 \pm 5^{\circ}\text{C}$
C	$30 \pm 10 \text{ sec}$
D	150°C
E	180°C
F	$90 \pm 30 \text{ sec}$

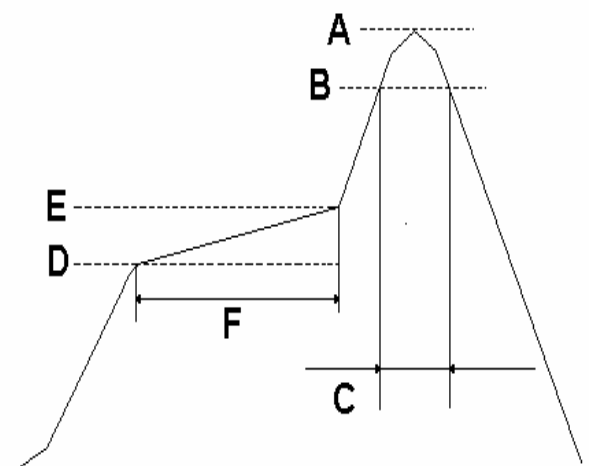

RELIABILITY TEST

Terminal strength

The terminal electrode and the body shall not be damaged by the forces applied on the right conditions.

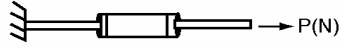

Type	P (kgf)	Time (s)
T□100505	0.3	
T□160808	0.5	
T□201209	0.6	
T□201212	0.8	
T□321611	1.0	
T□322513	1.0	30 ± 5
T□451616	1.0	
T□453215	1.5	
TA3216M4	0.5	

Bending strength

The body shall not be damaged by the forces applied on the right conditions.

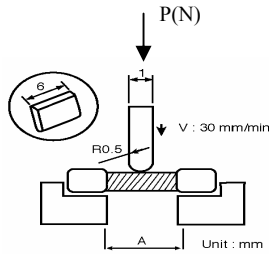

Type	A (mm)	P (kgf)
T□160808	1.0	0.5
T□201209	1.4	1.0
T□201212	1.4	1.2
T□321611	2.0	2.0
T□322513	2.0	2.5
T□451616	2.5	2.5
T□453215	2.7	2.5
TA3216M4	1.4	1.0

RELIABILITY TEST

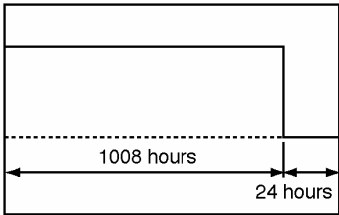
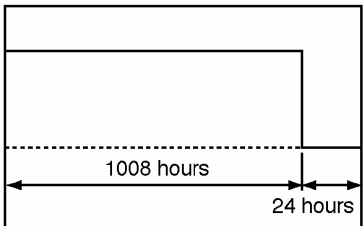
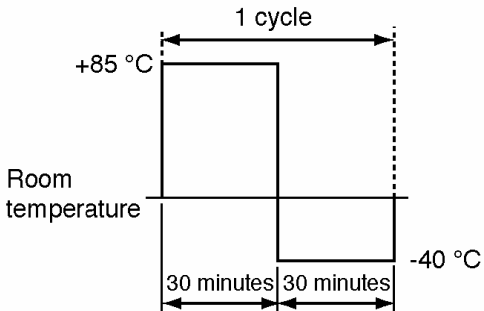
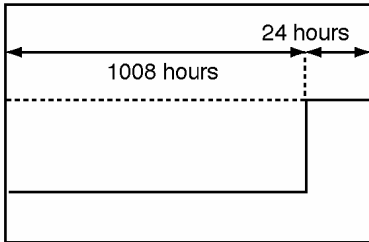
Item	Performance	Test condition
High temperature resistance	Appearance : Ferrite shall not be damaged. Inductance : Within±10% of the initial value. Q: Within±30% of the initial value.	Temperature: $85\pm 2^{\circ}\text{C}$ Testing time: 1008 ± 12 hours Measurement: After placing for 24 hours min 
Humidity resistance	Appearance: Ferrite shall not be damaged. Inductance: Within±10% of the initial value Q: Within±30 % of the initial value.	Humidity: 90 to 95% RH Temperature: $40\pm 2^{\circ}\text{C}$ Testing time: 1008 ± 12 hours Measurement: After placing for 24 hours min 
Thermal Shock	Appearance: Cracking, chipping or any other defects harmful to the characteristics shall not be allowed. Inductance: Within±10% of the initial value Q: Within±30% of the initial value.	Temperature: -40°C , $+85^{\circ}\text{C}$, kept stabilized for 30 minutes each Cycle: 100 cycles Measurement: After placing for 24 hours min 
Low temperature storage life test	Appearance: Cracking, chipping or any other defects harmful to the characteristics shall not be allowed. Inductance: Within±10% of the initial value. Q: Within±30% of the initial value.	Temperature: $-40\pm 2^{\circ}\text{C}$ Testing time: 1008 ± 12 hours Measurement: After placing for 24 hours min 

PACKAGING

- Tape dimensions and packaging quantities

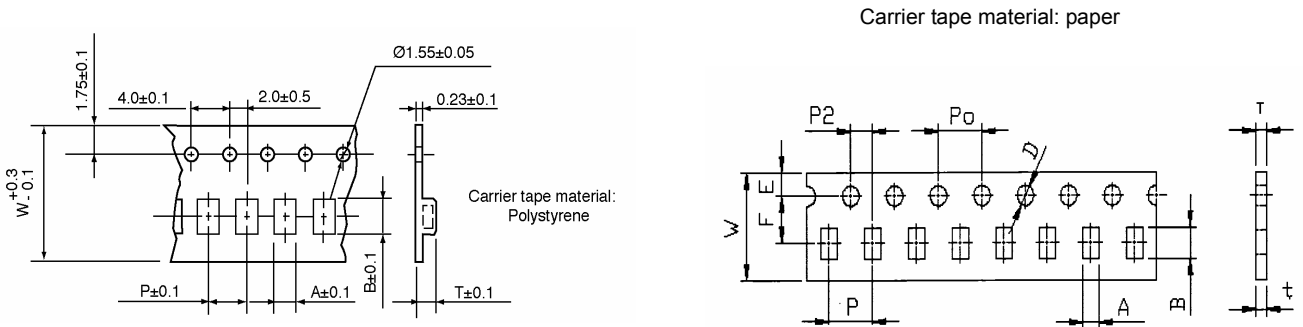

material: Paper (Dimensions in mm)						
TYPE	A	B	W	P	T	CHIPS / REEL
100505	0.62	1.12	8	2	0.60	10000
160808	1.10	1.90	8	4	0.95	4000
201209	1.50	2.30	8	4	0.95	4000
material: Polystyrene (Dimensions in mm)						
TYPE	A	B	W	P	T	CHIPS / REEL
160808	1.01	1.80	8	4	1.02	4000
201209	1.42	2.25	8	4	1.04	4000
201212	1.50	2.35	8	4	1.45	2000
321611	1.88	3.50	8	4	1.27	3000

- Reel dimensions

Material: Paper, Plastic

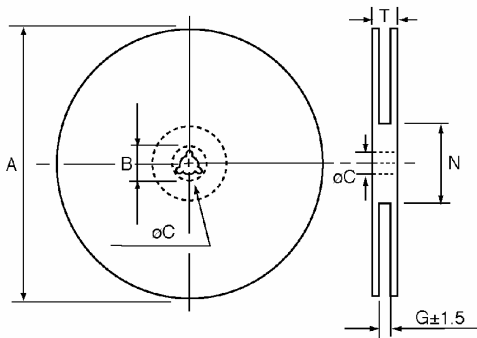

Dimensions in mm

TYPE	8mm	12mm
A	178±2	178±2
B	21.0±0.8	21.0±0.8
C	13.0±0.8	13.0±0.8
G	10.0	14.0
N	75	75
T	12.5	16.5

